

CENTER PIVOT SPAN CONNECTION COMPONENTS

Drains

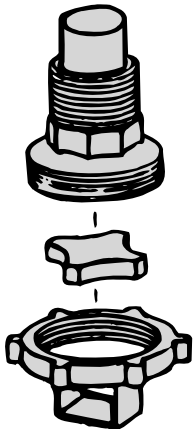

Valley Type Three-Piece Drains

For Valley Type as well as Many Other Brands of Systems

| NI Part # | Description |
|-----------|------------------------|
| 49003 | Upper Drain Body |
| 49009 | Drain Seal |
| 49001 | Lower Drain Body |
| 49029 | Complete 3-Piece Drain |

Spring-Loaded Drains

Aluminum Construction

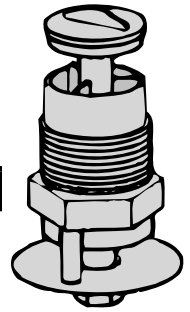

| NI Part # | Description |
|-----------|---------------------|
| 49008 | Spring-Loaded Drain |

Lindsay Type Drains

| NI Part # | Description |
|-----------|----------------------------------|
| 49005 | Drain, Multi-Pressure, 20-75 psi |
| 49031 | Drain, Low Pressure, 5-30 psi |

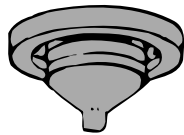

Mushroom Drains

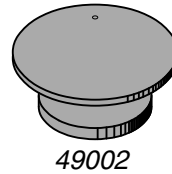

49002

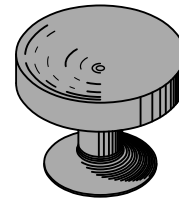

49002S

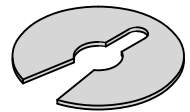

49007

| NI Part # | Description |
|-----------|---|
| 49002 | Double Mushroom Drain |
| 49002S | Double Mushroom Drain, LP Slow |
| 49007 | Mushroom Drain w/ Washer (both pieces included) |

Poppet Drains

Fits many center pivots and wheel roll sprinkler systems.

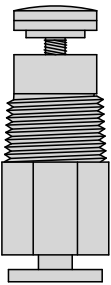

| NI Part # | Description |
|-----------|--------------|
| 49004 | Poppet Drain |

CHEMIGATION

Chemigation Drains

Install on supply side of check valves to drain leakage. Hose attaches to barbed "L" for waste disposal.

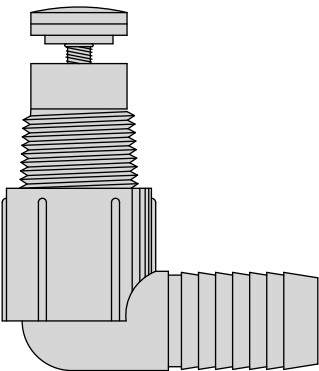

Chem Valve Drain, 90° x Barb
49011

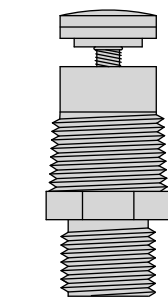

Chem Valve Drain w/ hose thread
49034

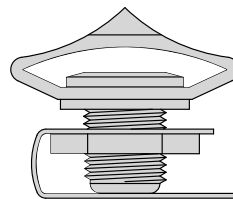

Chem Valve Bridge Drain
49037

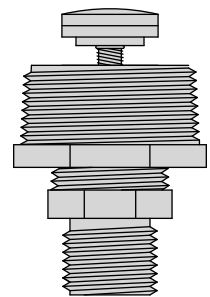

Chem Valve Drain w/ hose thread
49035

| NI Part # | Description |
|-----------|---|
| 49011 | Drain, Chem Valve, 90°, 1" M NPT x Barb |
| 49034 | Drain, Chem Valve, w/ Hose Thread |
| 49035 | Drain, Chem Valve, 1-1/2" M NPT x Male 3/4" Hose Thread |
| 49037 | Drain, Chem Valve Bridge, Pierce |

